



X RADIUS COMPACT  
FULL DIAGNOSTIC POTENTIAL  
WITHIN REACH

CASTELLINI.COM

X RADIUS COMPACT  
FULL DIAGNOSTIC POTENTIAL  
WITHIN REACH

**PLANT**

CEFLA s.c. - Via Biococca, 14/C  
40026 Imola (BO) - Italy  
Tel. +39 0542 653441  
Fax +39 0542 653601

**HEADQUARTERS**

CEFLA s.c. - Via Selice Provinciale, 23/a  
40026 Imola (BO) - Italy  
Tel. +39 0542 653111  
Fax +39 0542 653344

CASTELLINI.COM

Due to our policy of constant technological upgrading, the technical specifications may be subject to change without prior notice.  
According to the relevant regulations, in the extra-EU areas, some products and/or characteristics might have different availability and specifications. Please contact your local supplier. All images are for illustrative purposes only.

11/2019 CKRCrGB191S00



# SPACE-EFFICIENT, INTUITIVE AND BEST-IN-CLASS

X-Radius Compact combines the latest 2D and 3D imaging technologies with the smallest footprint in its category, a user-friendly software suite and complete with guided procedures to support your diagnostic potential. Excellent clinical performance is ensured despite exposure protocols which safeguard patient health by minimising radiation exposure.



# PRACTICAL AT EVERY STEP OF THE WAY

X-Radius Compact is immediately practical as it will fit into the smallest environments better than any of its rival devices. Extremely compact, the equipment can be ordered as a 3-in-1 solution including 3D, 2D and cephalometric functions. Combinations foresee 2D PAN upgradable to 2D PAN & CEPH or for volumetric imaging a choice between 3D PAN and 3D PAN & CEPH.



## **PAN TODAY. CEPH TOMORROW**

A complete 3D/PAN/CEPH solution is available at any time, but to enable a smaller investment initially, X-Radius Compact is easily upgraded after installation from 2D PAN or 3D PAN to either of these, by retrofitting a CEPH arm and cephalometric examination capability. X-Radius Compact brings clinical imaging within reach of dental surgeries wanting to progress step by step to increase their potential. Affordable and practical, the device enables subsequent integration of CEPH imaging capabilities to complement PAN functions on a 2D or 3D version.



The 3D detector rotates automatically to exit the CEPH scan trajectory and, fitted with a collimator shield down one side of the unit, descends sufficiently to provide the necessary collimation for CEPH exams.



## **RELOCATABLE SENSOR**

In the presence of the CEPH arm, the 2D sensor is detachable and can be switched conveniently from PAN to CEPH position. Manually released in all positions,

switching the sensor can be performed quickly and safely.

## **KEYPAD**

The control unit features a handy keypad incorporating the position reset button, up-down keys for column height and two keys to achieve TMJ centring or servo-assisted 2D (PAN/DENT), pre-scan focusing.

# SIMPLE WORKFLOW, GUIDED PROCEDURES

When a workflow is simplified thanks to intuitive controls and the support of easy-to-follow procedures, achieving correct diagnosis is faster and a step closer to satisfactory treatment outcomes. Operators are guided at all times in selecting the best-suited investigation protocols and the console helps users identify the appropriate mode, streamlining examination procedures.



## STARTING WITH USER-FRIENDLY CONTROLS

The virtual control panel, available for iPad and PC, guides operators through an easy procedure to select the examination type and allows acquired images to be viewed after scanning. 2D previews are available and dentists can also use the console to achieve correct alignment prior to 3D scans. Scout View images will also help obtaining volumetric data according to needs without needing to re-scan in case of inadequate positioning accuracy.

The guided procedure entails exam selection and FOV positioning. Correct parameters are ensured thanks to patented automatic exposure control mechanism which makes an assessment of patient build, calibrating the X-ray dosage according to the physical characteristics of the patient.



## LOW DOSE



## SPEED SCAN

Routine or post-surgical follow-up exams can be handled with low dosage scans, also suited to macro-structural analyses, as well as being ideal for children.

## REGULAR



## STANDARD SCAN

High-resolution 3D images obtained with standard scans are ideal for initial diagnosis and treatment planning.

## BEST QUALITY



## ULTRA SCAN

Top-quality, ultra-high-resolution scan mode for the most detailed, comprehensive volumetric data, especially for microstructures.

# LINED UP FOR A PERFECT SCAN

Castellini provides dentists with every means to achieve correct alignment as smoothly as possible. This leads to less time spent immobilised during the examination, which is crucial to obtaining volumetric data for precise diagnosis and positive treatment outcome.



## **STABILITY IN ALL SITUATIONS**

Laser guides further simplify precise positioning for all exams and assisted 3D centring for Scout Views complete the support features for volumetric scans.

The head support for 3D exams is comprised of 5 points of contact of which three can be adjusted to fit the anatomy of each patient. Extended head support elements, together with a nasal support are used to achieve optimal positioning for examinations of the maxillary sinuses.

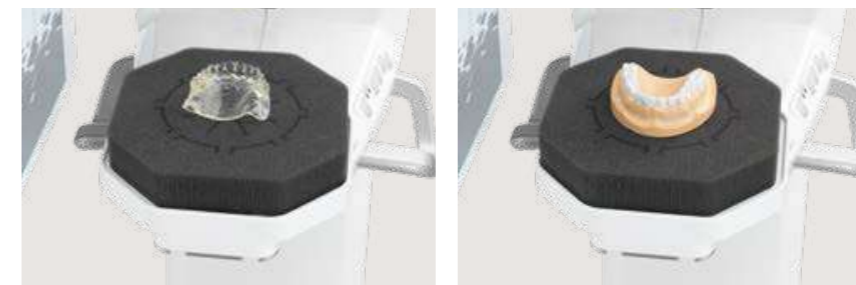

## **ACCESSORIES FOR TOMOGRAPHIC SCANS**

A specific protocol is available for scanning of surgical guides, dental impressions and other three-dimensional objects, which can be placed on the appropriate tray.

# BEST RESULTS COME WITH EASY POSITIONING

A key aspect which leads to the best 2D image and consequently influences the accuracy of a diagnosis is related to patient positioning. Making it easy and highly practical, dentists are able to count on laser guides, an adjustable head support and simple controls to achieve first-time success.



## **ACCURACY IS NEVER LEFT TO CHANCE**

Laser guides to locate the mid-Sagittal and Frankfurt planes, plus a third guide focusing on the canine, help achieve positioning accuracy and successfully accomplished panoramic images. The head support with its 4 contact points has adjustable lateral rods and easily replaced bite and nasal support. Obtaining the desired 2D image immediately, thanks to reliable positioning and stability, means exposing the patient to just one scan with no need to repeat the examination.



## **VERSATILITY**

Positioning for lateral and anterior projections is easy thanks to the flexible head support which can be adjusted according to the specific exam requirements.

## **CARPUS POSITIONING**

A Plexiglas panel representing the carpus helps speed up image acquisition to assess residual growth.

## **CEPH POSITIONING**

The head support on the teleradiographic arm includes two lateral and one frontal support rods. Extended lateral versions are available for children in order to minimise exposure of the thyroid gland.

# AN ETHICAL APPROACH TO DIAGNOSTIC IMAGING

Without altering the high quality of the images obtained, X-Radius Compact makes patient health and safety a priority. First of all, short scan times eliminate unnecessary exposure to radiation in respect of the ALARA principle. Accurate positioning for added comfort, as well as SCOUT VIEWS also ensure first-time satisfactory images and no need to repeat acquisition. Low dosage, variable scan-specific collimation, pulsed emissions and high-speed scans all contribute to safeguarding patient health.



## SIMPLE DENTITION

The exposure area can be adjusted according to the actual X-ray imaging needs for adults or children to include the whole or partial dentition, also dividing it into Bitewing quadrants or sectors.

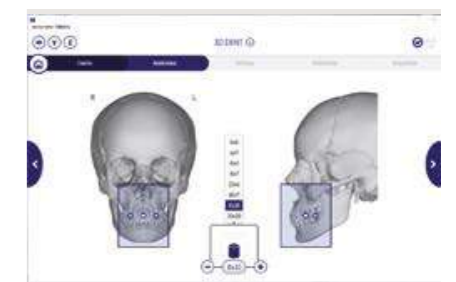

## DYNAMIC 3D FOV

The dynamic FOV selection makes it possible to limit the exposure only to the area of interest and perform dedicated analyses for various applications, both for adults and children.



## X-SAFE AUTOMATIC EXPOSURE CONTROL (MRT)

Thanks to this technology, patient morphology is assessed prior to exposure, so that X-ray dosage is calibrated according to the actual physical characteristics and build of the person being examined. This results in suitable clinical images and avoids unnecessary exposure.

# CLINICAL DIAGNOSTICS MADE ACCESSIBLE

X-Radius Compact covers the majority of needs for clinical investigations and image-based diagnoses, including 2D PAN, CEPH and 3D capabilities. A series of automatic functions and the versatile concept behind the equipment enable excellent workflow and lead to optimal results.

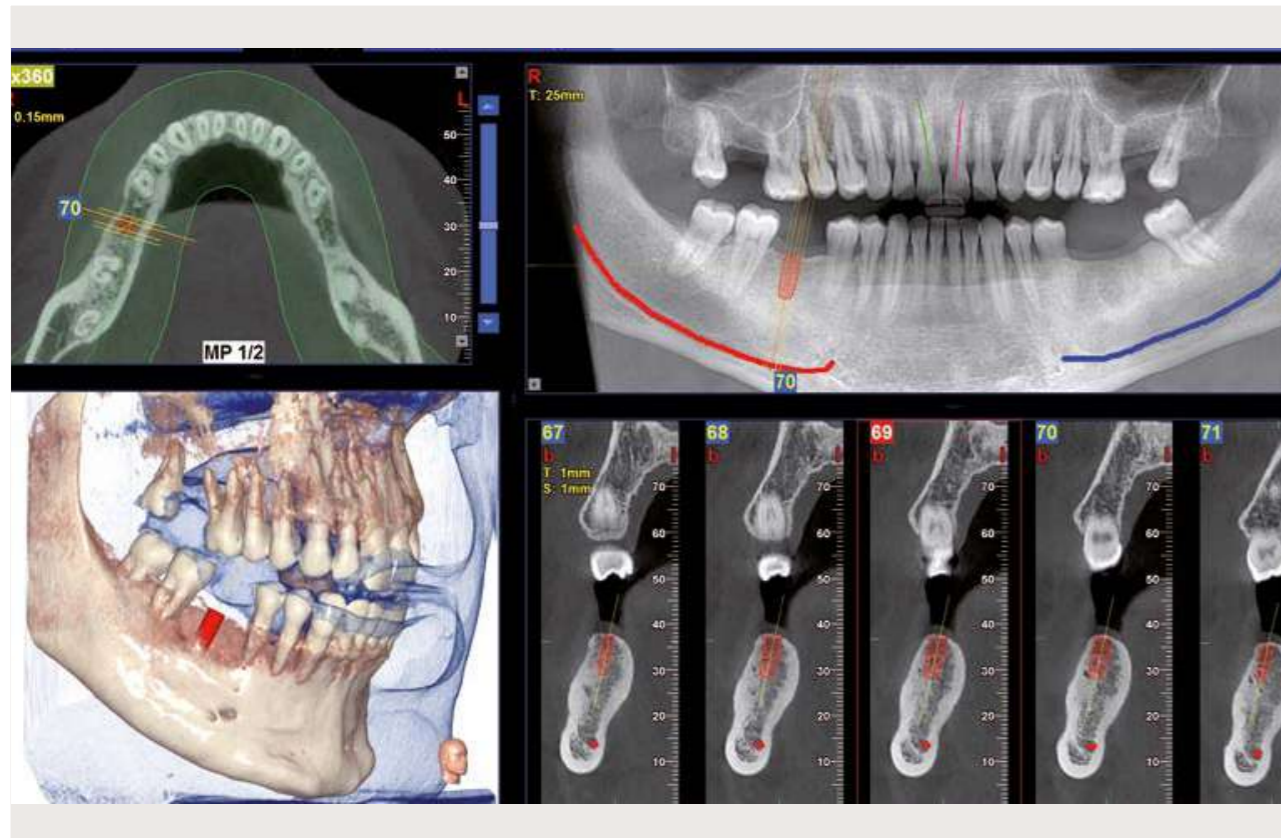

## 3D FLEXIFOV EXAMINATIONS

Defined according to diagnostic requirements and ranging from a minimum of 6 x 6 cm to a maximum of 10 x 10 cm, the three-dimensional field of view is selected via the guided procedures on the virtual control panel. Minimising scan times to what is essential, a wealth of data is obtained in a single scan, allowing for an in-depth study of the anatomical features.

The variable collimator automatically sets the field of view when just a small portion [e.g. 6 x 6 cm] is required. The flexibility of having a multiple choice for the FOV also benefits the patient by limiting exposure wherever possible.

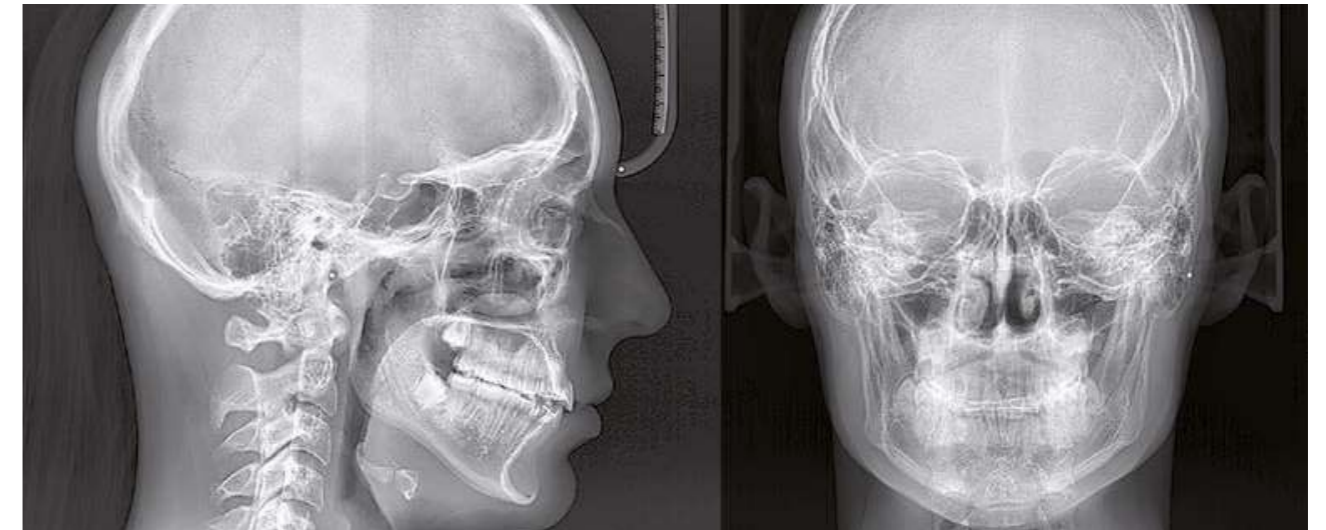

## SUPERIOR CEPH

The compact arm, complete with its own 2D sensor, has long and short head support rods for adults and children. Using a reduced scan in combination with a fast scan minimises X-ray exposure while using short rods for children prevents unwanted exposure to the thyroid gland.

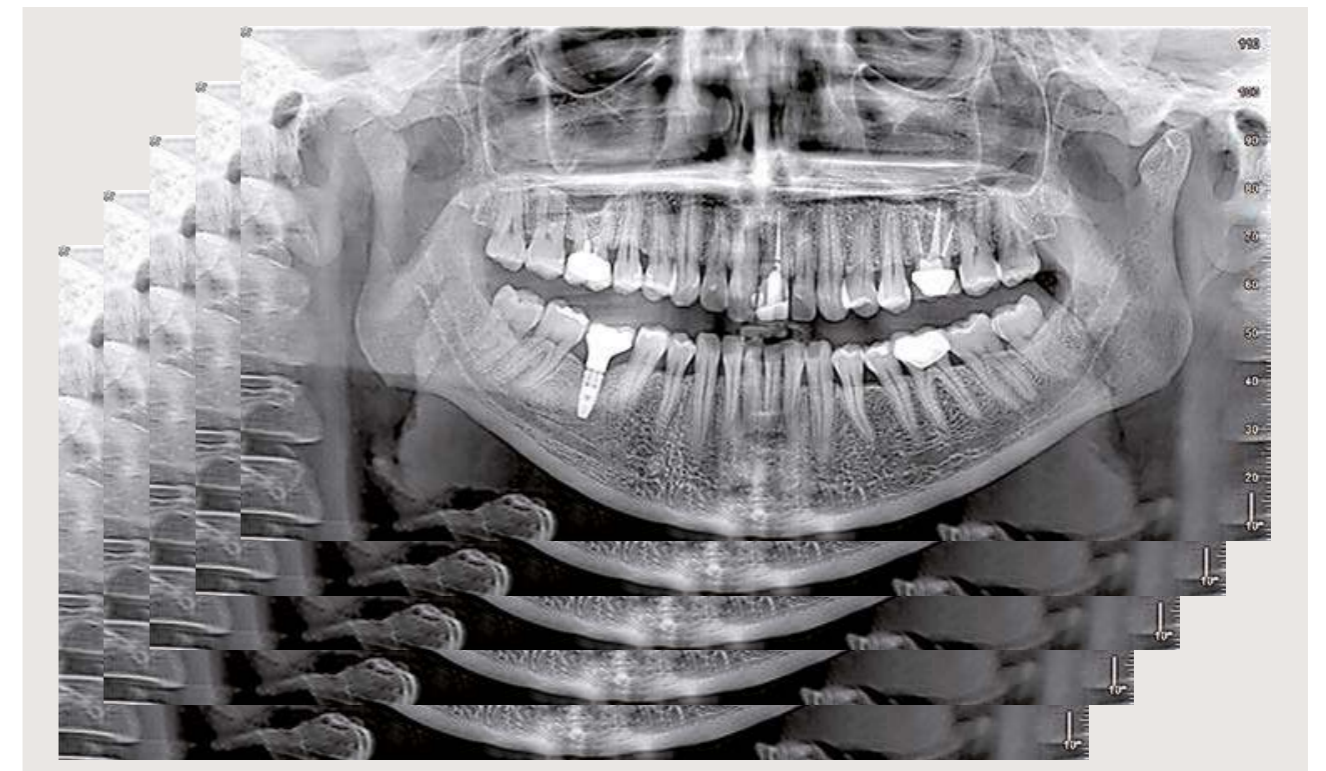

## MULTILEVEL PAN ORTHO

Performing a single scan in MultiLevel mode, X-Radius Compact acquires a set of 5 panoramic images corresponding to five different focal planes. This allows users choose the panoramic image best suited to highlighting the detail of clinical interest. The new orthogonal panoramic function highlights interproximal spaces and the entire root structure without any overlap thanks to orthogonal projections.



# BROAD SCOPE FOR CLINICAL 2D IMAGING



## PATIENT-CENTRIC SOFTWARE - iRYS

With a software suite designed to enable simple and immediate access to a wealth of clinical data, X-Radius Compact makes the most of image quality and intuitive image management. Centred around each patient's clinical records, both intraoral and extraoral images are handled by easy-to-use software iRYS, enabling efficient and complete handling of all relevant information. Ideal for quick, accurate diagnoses, also thanks to specially conceived filters which instantly improve image quality.

iRYS has obtained the ISDP certification © 10003, international scheme for the assessment of compliance with the European Regulation 2016/679 concerning the protection of individuals with regard to the processing of personal data. A powerful image Enhancement System (IES) always leads to optimal image visualisation, automatically applied, according to your preferred pre-established settings.



IES



in accordance with EN ISO /IEC 17065:2012

X-Radius Compact is extremely versatile and offers the broadest range of diagnostic protocols for adults and children. Exposure is always adjusted to the actual needs, so as to minimise the dose as much as possible. 2D examinations include complete panoramic images, high-resolution images of dentition and bitewing, as well as TMJ views and those of the maxillary sinuses. The latest-generation iRYS software enables optimal images for clinical purposes.



## PERIODONTAL PROCEDURES (ORTHO PAN)

Panoramic X-ray with superior orthogonality or standard for complete clinical analysis.



## PAEDIATRIC DENTISTRY (CHILD PAN)

Full panoramic view with limited exposure area and fast or partial scanning with minimum dose.



## PARANASAL SINUSES (SIN)

Maxillary sinuses with frontal and side views to detect pathology present in the patient.

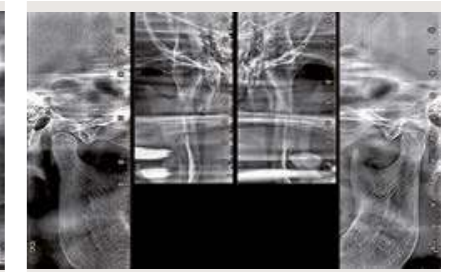

## GNATHOLOGY (TMJ)

Examination of the temporomandibular joint with open and closed mouth, frontal and side views.



## CONSERVATIVE DENTISTRY (DENT & BITEWING)

High-resolution partial scan of dentition optimising the interproximal view.



## ORTHODONTICS (TELERADIOGRAPHY)

Analysis of complete lateral or frontal AP/PA for cephalometric examinations, supported by Ceph-X Artificial Intelligence tool for tracing and sharing on the cloud.

# 3D CAPABILITIES TO COVER ALL CLINICAL NEEDS

X-Radius Compact provides a wealth of examination possibilities to obtain rich volumetric data suitable for countless clinical investigations. Complete or partial views for both adults and children in 3D, handled by a dedicated software suite, are available for dental surgeons, implantologists, orthodontists and specialists in endodontics. Eight different FOVs range from 10 x 10 to 6 x 6 cm.

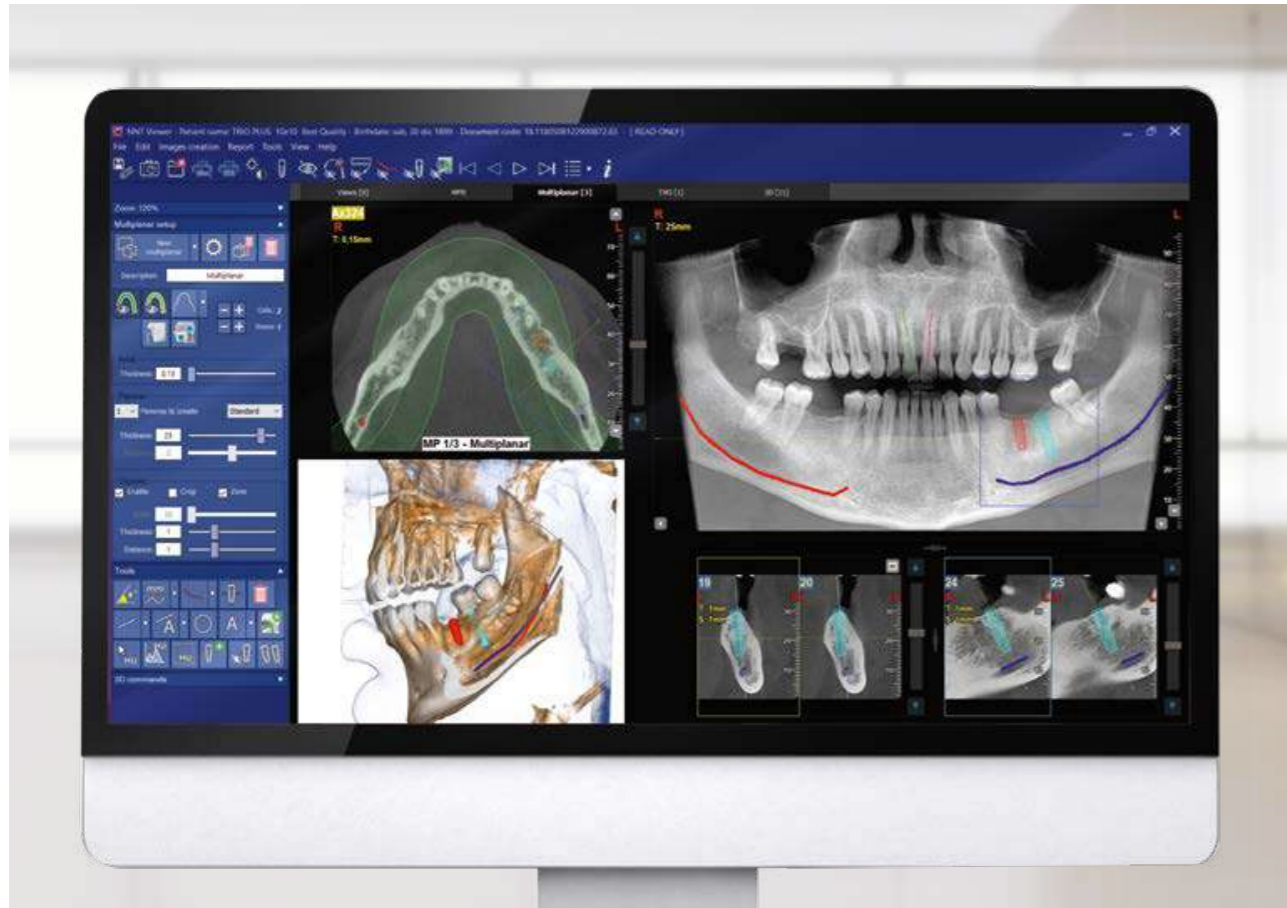

## COMPLETE SUPPORT FOR IMPLANTOLOGISTS

A comprehensive software suite assists implantologists with surgical planning. Included are a library of implants, implant simulation procedures to assist with positioning supported by 3D renderings. With its intuitive interface, iRYS software allows for real-time adjustments on screen. Supported by specific software programmes, dentists will obtain comprehensive clinical data for all dentistry applications such as implant planning simulation with volume and bone density evaluation and volume analysis of maxillary sinuses. Excellent 80 µm resolution details obtained for both upper and lower arches.

Metal Artifact Reduction filters will significantly reduce artifacts caused by amalgam or implants that would otherwise compromise planning of specialist treatments requiring segmentation of anatomical structures.



MAR

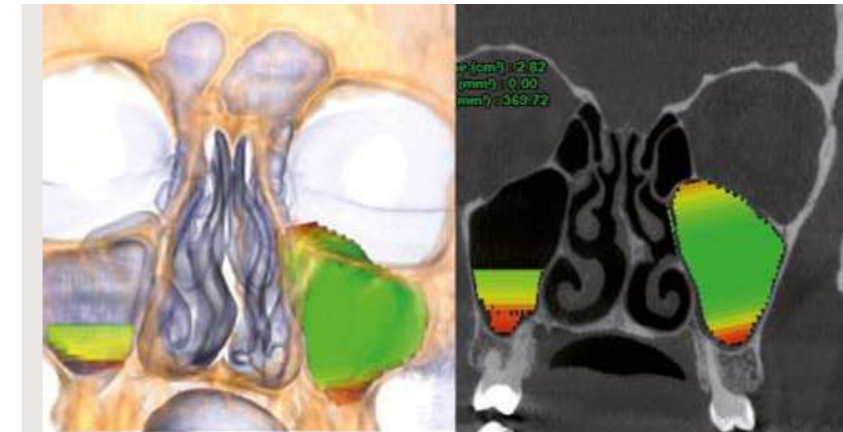

## SINUS-LIFT SIMULATION (FOV 10X10)

Upper dental arch analysis, including the maxillary sinuses, to correctly plan a sinus lift for implant surgery with volume analysis.

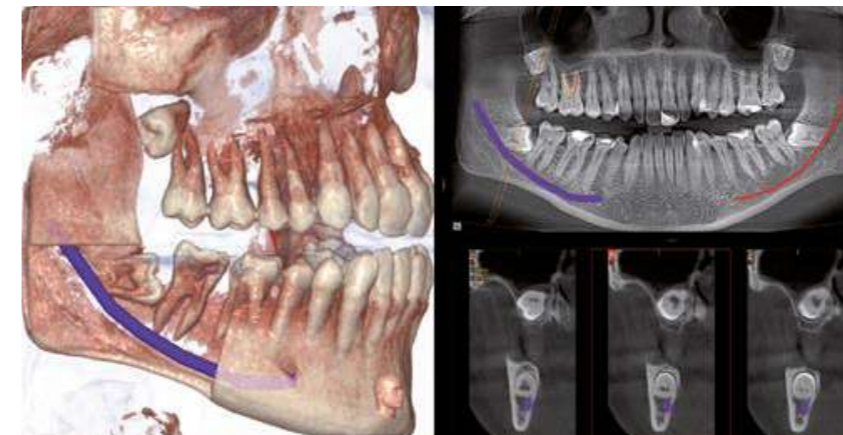

## ORTHODONTIC TREATMENT (FOV CHILD 8X7; ADULT 10X10)

Low Dose Analysis of full adult dentition, including the third molars, or child dentition, to provide a correct treatment assessment also with impacted or supernumerary teeth.

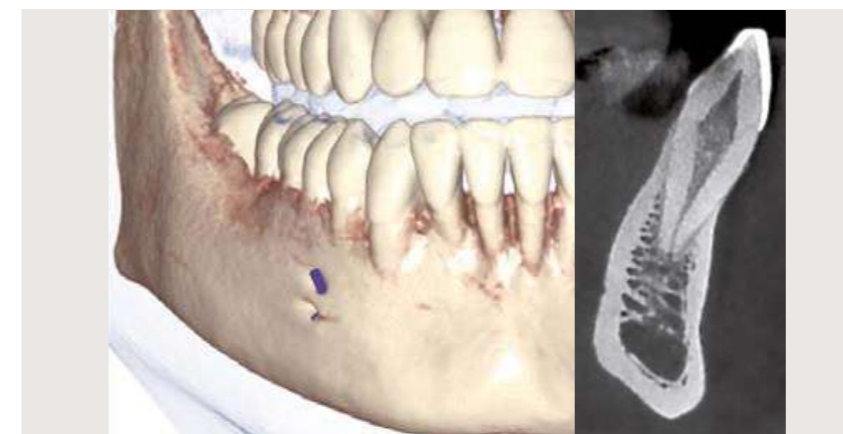

## ENDODONTIC ANALYSIS (FOV UPPER 6X6 / LOWER 6X7)

Localised high-definition (80 µm) analysis with exposure limited only to the area of interest.

# CONNECTING A WORLD OF PROFESSIONALS

Available across all platforms and operating systems, and with full cloud connectivity making information easily available, the guided surgery software suite ensures the most efficient workflow for all professionals involved. Data sharing, advanced functions and a secure chat lobby for immediate connections are part of this powerful suite designed to optimise and reduce the time required for implant surgery, perfecting its outcome as much as its integrated procedures.

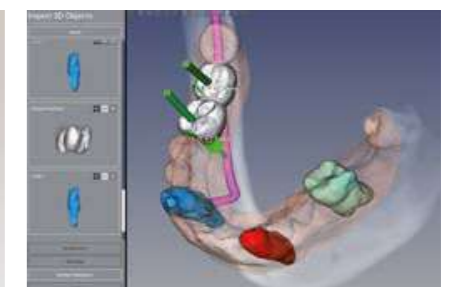

#### ANATOMICAL SIMULATION

Simulating patient anatomy to facilitate procedures, software provides a precise volumetric environment to perform implant surgery in the safest way.

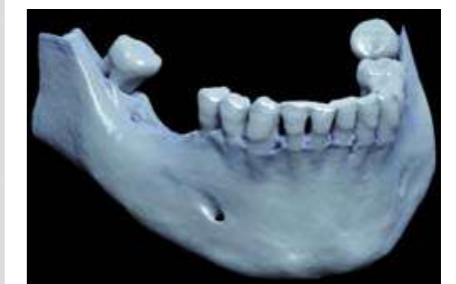

#### STL FILES

Using artificial intelligence, anatomical structures are segmented and exported as STL files. Data are used to perfect implant procedures.

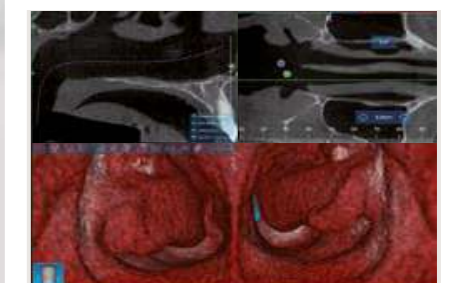

#### VIRTUAL ENDOSCOPY

The dental surgeon performing implant surgery is able to act according to real data making the operation safer, more effective and minimising the invasive aspects.

# TECHNICAL SPECIFICATIONS

IMAGES	2D	3D
Type	Complete or partial adult and child panoramic*, Orthogonal Panoramic, SPEED PAN, MultiLevel PAN, Dentition, Bitewing* Frontal and Lateral (right and left) maxillary sinuses, Temporomandibular Joint (2 x Lateral + 2 x Frontal) open and closed mouth. Teleradiography: Skull AP-PA, LL Short/Long, Standard/Quick; Carpal teleradiography	Complete examination of the 2 arches in a single scan for adults and children (reduced collimation); Examinations of the maxillary region with maxillary sinuses; Examination localised in the region of interest.
(Maximum) theoretical resolution on the patient plane	2D: 5-7 lp/mm (pixel 100-73 µm) CEPH: 6 lp/mm (Pixel 89 µm)	≥ 6 lp/mm (Voxel 80 µm)
Equivalent size on X-ray transparency (cm)	PAN: 26.2 (length); 14.4 (height) CEPH: 29.2 (length); 22 (height)	
Fields of view on patient (mm)	PAN: 210 (length) x 115 (height) CEPH: 258 (length); 194 (height) PAN Child: 180 (length) x 100 (height) Dentition: 140 (length); 100 (height) Bitewing: 167 (length); 70 (height)	DENT and SIN: 100 (diameter) x 100 (height) 100 (diameter) x 70 (height); 100 (diameter) x 60 (height) 80 (diameter) x 70 (height); 80 (diameter) x 60 (height) 80 (diameter) x 100 (height); 60 (diameter) x 70 (height); 60 (diameter) x 60 (height);
Maximum image data dimensions	PAN: 7.5 MB (single image) CEPH: 14 MB	720 MB
Magnification	PAN 1.2 - 1.3 CEPH 1.13	1 to 1 (Isotropic voxel)
Scan time	PAN: 13.8 s (ORTHO), 12.3 s (STD.), 6.8 s (Speed) CEPH: 9.9 s (STD) - 3.7 s (Speed)	ULTRA SCAN: 16.8 s (Best Quality) STANDARD SCAN: 9.6 s (Regular) SPEED SCAN: 6.4 s (Low Dose)
Estimate of typical effective dose (ICRP 103)	PAN: 5 - 9 µSv	FOV: 10x10   35 µSv (Voxel 150 µm) - 80 121 µSv (Voxel 80 µm) FOV: 6x6   9 µSv (Voxel 150 µm) - 27 40 µSv (Voxel 80 µm)
Minimum image display times	RealTime	15 s
Advanced filters	iES (Image Enhancement System) PAN autoFocus	MAR (Metal Artifact Reduction)

\*Optional vertical collimation on 2D PAN version (included in the version "CEPH Ready" and 3D)

INSTALLATION	CEPH READY VERSION	CEPH LEFT VERSION
Minimum space requirement (L x D)	872 x 1030 mm	1785 x 1030 mm
Package dimensions (L) x (P) x (H) in mm	Box1 930 x 690 x 960 (machine base) Box2 1860 x 355 x 350 (floor-mounted)	Box1 930 x 690 x 960 (machine base) Box2 1860 x 355 x 350 (floor-mounted) Box3: 575 x 1275 x 380 (teleradiographic arm)
Machine Weight	2D version: 87 kg (192 lb) 3D version: 99 kg (218 lb)	2D version: 108 kg (238 lb) 3D version: 120 kg (264 lb)
Accessories	PAN self-standing base	CEPH self-standing base

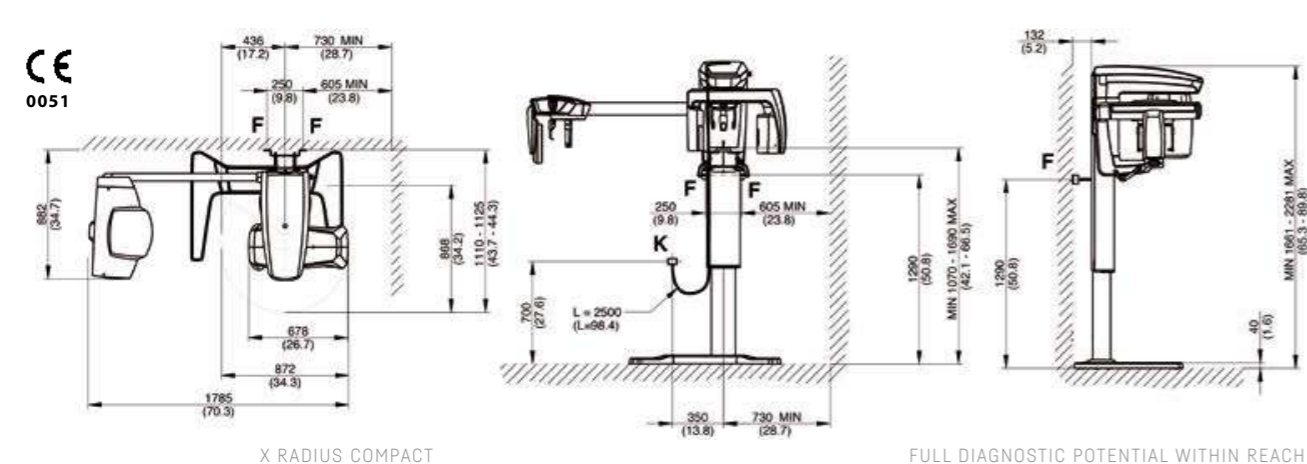

X RAY COMPACT

FULL DIAGNOSTIC POTENTIAL WITHIN REACH

ERGONOMICS	
Examination selection	Procedure guided from virtual control panel on PC and/or iPad
Patient positioning	Suggestion from virtual control panel - Servo-assisted alignment, 3 laser guides (Class 1 - IEC 60825-1) - 3D Scout View
Patient head support	Efficient 4 contact point 2D version - 5 contact point version, adjustable 3D/2D right/left
Adjustments	2-speed height adjustment drive Keypad on the machine and/or iPad app Servo-assisted alignment: Keypad on machine or remote control (via Scout View)
Other functions	Multilingual, parking position, remote control
Notes	Easy access for patients in wheelchairs

2D VERSION - X-RAY GENERATOR	
Generator type	Constant potential (DC)
Anode voltage	2D: 60-85 kV continuous emission 2D 70 kV: 60-70 kV continuous emission
Anode current	4 mA - 15mA
Focal spot	0.5 mm (IEC 60336)
Exposure Control	Automatic. X-Safe Technology
Maximum continuous anode input power	42W (1:20 at 85kV/10mA)
Inherent filtration	> 2.5 mm Al eq. (at 85 kV)

DETECTOR 2D PAN & CEPH	
Detector type	CMOS (CSI)
Dynamic range	14 bit (16384 grey levels)
Height	PAN: 148 mm CEPH: 223 mm

3D VERSION - X-RAY GENERATOR	
Generator type	Constant potential (DC)
Anode voltage	3D mode: 90kV pulsed emission (25% ON - 75% OFF) 2D mode: 60-85 kV continuous emission
Anode current	4 mA - 15mA
Focal spot	0.6 mm (IEC 60336)
Exposure Control	Automatic. X-Safe Technology
Maximum continuous anode input power	42W (1:20 at 85kV/10mA)
Inherent filtration	3D mode: 90kV pulsed emission (25% ON - 75% OFF) 2D mode: 60-85 kV continuous emission

DETECTOR 3D/PAN	
Detector type	Amorphous Silicon (CSI)
Dynamic range	16 bit (65536 grey levels)

DETECTOR 2D CEPH	
Detector type	CMOS (CSI)
Dynamic range	14 bit (16384 grey levels)
Height	CEPH: 223 mm

POWER SUPPLY	
Voltage   Frequency	115 - 240 V Single-phase   50 / 60 Hz
Maximum absorbed surge current	20A at 115V; 12A at 240V
Current absorption in standby mode	Maximum 0.5A (240 V); 1A (115 V)
Notes	Automatic adaptation for voltage and frequency

CONNECTIVITY	
Connections	LAN / Ethernet
Image management software	CASTELLINI iRYS (compliant with the ISDP scheme © 10003: 2018 in accordance with EN ISO / IEC17065: 2012 - certificate number 2019003109-1) and iPad iRYS viewer app (free). STL (RealGUIDE)
Supported protocols	DICOM 3.0, TWAIN, VDDS, CLOUD shared (RealGUIDE)
DICOM nodes	IHE compliant (Print; Storage Commitment; WorkList MPPS; Query Retrieve)
Virtual Control Panel	PC and iPad

dimensions in millimetres (dimensions in inches)